

Diameter range of base tube of 3/4" up to 2", fin number per inch: 6 – 11

**HIGH FINNED TUBES**

**Fin-material:** aluminium (some versions copper as well).

**Base-tube-material:** all materials (embedded types are limited).

**Maximum length:** up to 20 meters.

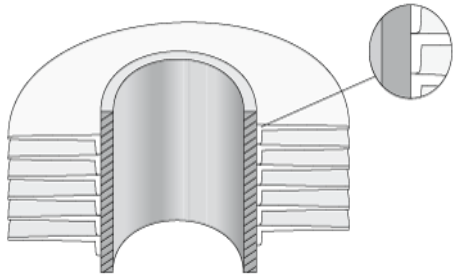

**L-FIN**  
 Temperature 130°C (270°F)

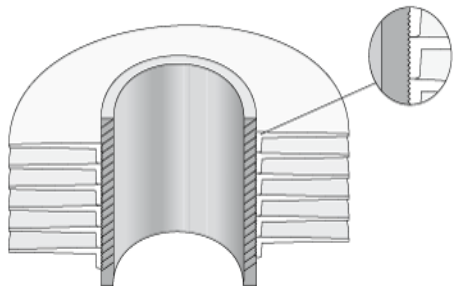

**KL-FIN**  
 Temperature 250°C (480°F)

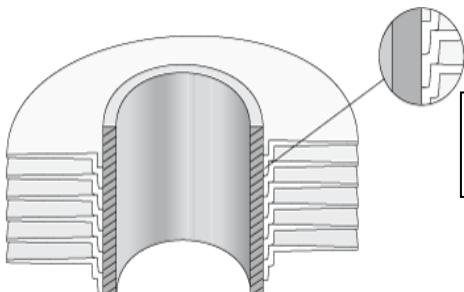

**LL-FIN (double L)**  
 Temperature 165°C (330°F)

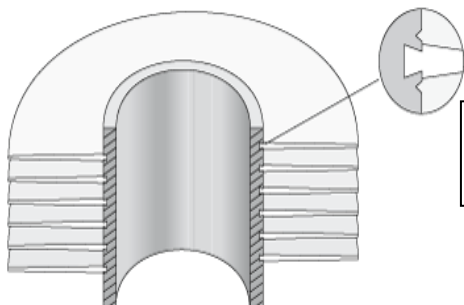

**G-FIN**  
 Temperature 400°C (750°F)

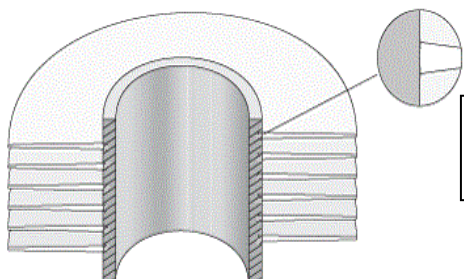
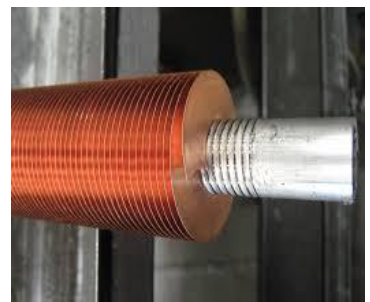

**I-FIN**  
 Temperature 380°C (729°F)



Diameter range of base tube of 3/4" up to 2", fin number per inch: 6 – 11

### EXTRUDED TUBES

**Fin-material:** Al, Cu fins are integrally produced through in thread rolling process.

**Base-tube-material:** all materials

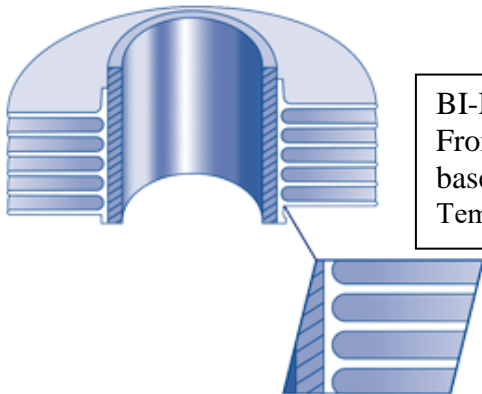

**BI-METALIC TUBES**  
From soft metal tube on a  
base tube.  
Temperature 280°C (547°F)

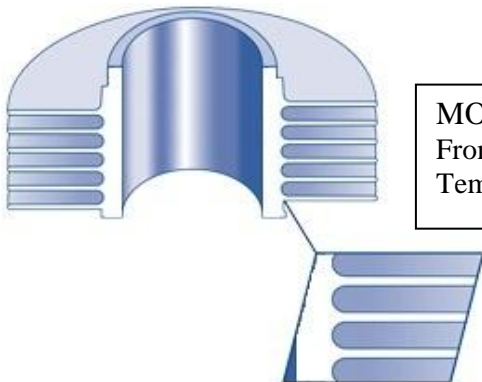

**MONO-METALIC TUBES**  
From soft metal tube on a plug.  
Temp. acc. to sort of material

